



Cable protection safety and performance considerations for commercial & heavy-duty vehicles

Electrification

ABB Installation Products Division
Thoughts & Perspectives



**Protecting critical electrical and
electronic wiring assemblies in the
automotive industry.**

Cable protection safety and performance

considerations for
commercial &
heavy-duty vehicles

Electrification

ABB Installation Products Division
Thoughts & Perspectives

Around the world, millions of commercial vehicles and farm and heavy-duty equipment travel billions of miles each year. These types of vehicles often operate in the toughest conditions and harshest environments.

Some vehicles are in service for long hours or travel across treacherous terrain, putting strain on the vehicle's electrical wiring in addition to the damaging impacts of vibration, corrosion and regular power jet washing.

A vehicle's electrical wiring is its heartbeat and helps drive its performance, productivity and reliability, all of which impact its cost of ownership. It's crucial that a vehicle is safely protected at critical junctions. Without correct and reliable harness protection, commercial and heavy-duty vehicles can be vulnerable to reduced productivity due to increased downtime and more frequent, costly repairs.

Touching our lives every day. From delivering the food and products we use to the construction equipment and transportation vehicles that build and maintain our communities, our lives are touched every day by commercial and heavy-duty vehicles (HDVs).

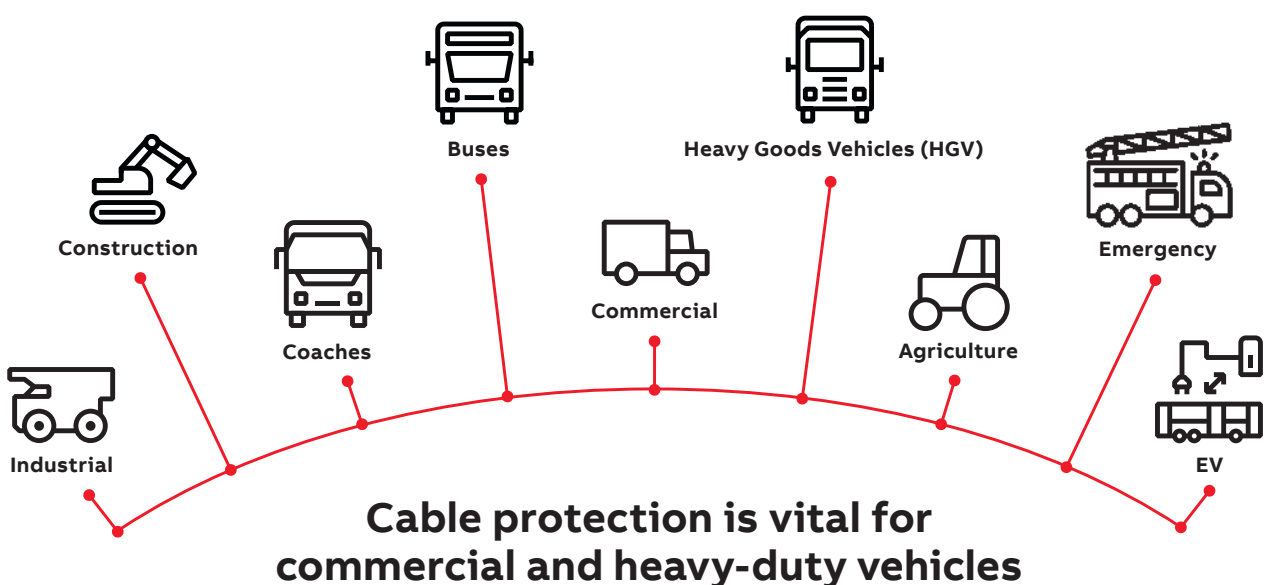

Approximately

26%+



of emissions are from commercial and heavy-duty vehicles.



1 Cable management

Although cable protection is important for regular passenger cars, it's critical for agricultural and construction equipment, lorries, buses, and other heavy-duty utility and emergency vehicles operating in extreme conditions. Cable management is increasingly crucial for modern engines and electric vehicles.

The lower the emissions, the hotter the engine. Modern engine design has evolved in recent years to improve safety and efficiency and reduce noise. These enhancements and the changes required to meet evolving emissions targets translate to higher engine temperatures. To safeguard these systems, cable management is especially and increasingly crucial for modern engines and electric vehicles.

A changing regulatory environment and the shift to electric everywhere. The transportation sector is one of the largest contributors to anthropogenic greenhouse gas (GHG) emissions globally.

According to the Inventory of U.S. Greenhouse Gas Emissions and Sinks 1990–2020 (the Inventory), the national inventory that the U.S. prepares annually under the United Nations Framework Convention on Climate Change (UNFCCC), the transportation sector accounted for the largest portion (27%) of total U.S. GHG emissions in 2020. **Medium- and heavy-duty trucks made up the second largest category, with 26% of total emissions.** When including emissions from non-transportation mobile sources such as agricultural, lawn and garden, and construction equipment, mobile sources constituted **31% of total U.S. GHG emissions in 2020.**¹

Medium- and heavy-duty trucks are considered vehicles with a gross vehicle weight rating (GVWR) of more than around 8,500 pounds. In the inventory, single unit trucks and combination trucks represent the medium- and heavy-duty truck category, including tractor-trailers and box trucks used for freight transportation.

In addition, this category includes some vehicles not typically used for freight movement such as service and utility trucks. In 2020, medium- and heavy-duty trucks traveled an average of 317,245 million vehicle miles.

¹ U.S. Environmental Protection Agency, <https://www.epa.gov/greenvehicles/fast-facts-transportation-greenhouse-gas-emissions>, Office of Transportation and Air Quality EPA-420-F-22-018 May 2022, <https://nepis.epa.gov/Exe/ZyPDF.cgi?Dockey=P10153PC.pdf>



Harnessflex® conduit systems provide

10-150%



greater life expectancy in dynamic or vibrating applications.

Growing EV adoption and infrastructure.

To support commercial fleets and public transportation, the United States, along with vehicle OEMs, has set the ambitious target that half of all new U.S. vehicle sales are to be electric by 2030. ABB E-mobility is a global EV charging infrastructure company that is investing in EV charger manufacturing around the world. This includes facilities capable of producing up to 10,000 EV chargers per year, ranging from 20 kW to 180 kW in power for public use, school buses and fleets.

As part of the EU's commitment to climate change under the Paris Agreement, Regulation (EU) 2019/1242 went into effect in August 2019, setting new emission standards for heavy-duty vehicles and aiming to reduce 54 million tons of CO₂ emissions by 2030. These emission standards initially cover large trucks, which account for **65 to 70% of all CO₂ emissions** from heavy-duty vehicles. In 2025, manufacturers will face significant financial penalties if emission target levels are not being met. The scope may also extend to a broader range of vehicle types such as buses, coaches, tractors and other agricultural equipment.

Over 75% of trucks sold in 2021 were covered by fuel economy or vehicle efficiency regulations, up from 60% in 2016. The availability of electric HDV models continues to expand across all leading global markets. Sales of electric buses increased by 40% in 2021 and electric truck sales more than doubled, even while total sales remained approximately the same as in 2020. China accounted for over 90% of these, although registrations in Europe and the United States also increased.³

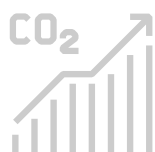

2 Rising demand

Rising demand for freight transport means heavy-duty vehicles (HDVs) contribute an increasing share of carbon emissions.

By 2025, the **global HDV fleet** is projected to contribute more greenhouse GHG emissions than the light-duty vehicle fleet. Zero-emission vehicle (ZEV) technology for HDVs, including battery electric vehicles and fuel-cell electric vehicles, has the potential to significantly reduce climate and air quality impacts such as those in emerging markets and developing economies (EMDEs). Decarbonising transportation will require cleaner engines and fuels, technological advances, and **electrifying 29% to 81%** of the global heavy-duty fleet by 2050.

Like the HDV electrification trend in major vehicle markets, EMDEs are prioritising public transport for electrification. This includes buses, which have great potential for electrification because they typically have consistent trip schedules and can be charged overnight at depots, reducing the need for a dense network of en route charging points. Moreover, electric buses are shown to be cost-effective (in terms of total cost of ownership) compared to internal combustion engine (ICE) technology in selected markets, considering the typical functional lifetime of buses, which can range from 8 to 15 years depending on the market.²

² International Council on Clean Transportation, <https://theicct.org/insight-analysis/>

³ International Energy Agency, IEA (2022), **Global EV Outlook 2022**, IEA, Paris <https://www.iea.org/reports/global-ev-outlook-2022> and <https://www.iea.org/reports/trucks-and-buses>

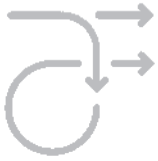

3 Equipment

Examining equipment and environments where cable protection and performance are essential. Focusing on a diverse range of commercial and heavy-duty vehicles, ABB's Harnessflex® products team works closely with many original equipment manufacturers (OEMs) and heavy-duty vehicle engineers to develop cable management and protection solutions for electrical connectors and systems – a critical area of a vehicle's engine wiring harness. Harnessflex is a leading designer and manufacturer of flexible conduit systems and connector interfaces that protect critical electrical wiring in the automotive industry, including chassis and engine manufacturers within bus, agricultural and heavy-duty vehicle markets.

Types of commercial and heavy-duty vehicles across industries:

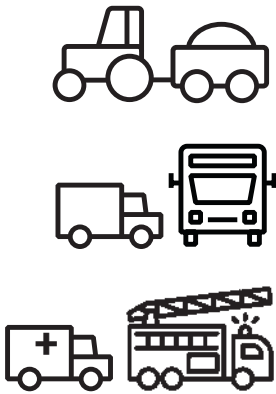

- **Equipment and machinery** – agricultural, construction, forestry and logging, highway and paving, mining, mobile cranes, cement mixers, and refuse trucks
- **Transportation and delivery** – school and public transit buses, freight, and other fleet vehicles, including tankers, lorries and tractor trailers designed to pull refrigerated trailers, dry vans and other equipment
- **Utility and emergency** – ambulances, fire and rescue, and defense

There are **eight truck classes**, categorised by the GVWR that the vehicle is assigned when it is manufactured. These categories are used by the trucking industry and many government agencies to classify trucks:⁴

- **Class 1 - 6,000 lbs & Less**
Minivan / Cargo van / SUV / Pickup truck
- **Class 2 - 6,001 lbs to 10,000 lbs**
Minivan / Cargo van / Full-size pickup / Step van
- **Class 3 - 10,001 lbs to 14,000 lbs**
Walk-in / Box truck / City delivery / Heavy-duty pickup
- **Class 4 - 14,001 lbs to 16,000 lbs**
Large walk-in / Box truck / SUV / City delivery
- **Class 5 - 16,001 lbs to 19,500 lbs**
Bucket truck / Large walk-in / City delivery
- **Class 6 - 19,501 lbs to 26,000 lbs**
Beverage truck / Single-axle / School bus / Rack truck
- **Class 7 - 26,001 lbs to 33,000 lbs**
Refuse / Furniture / City transit bus / Truck tractor
- **Class 8 - 33,001 lbs & Over**
Cement truck / Truck tractor / Dump truck / Sleeper

From multipurpose commercial vehicles, starting at 5,000 pounds, up to the world's largest equipment weighing thousands of tons, ABB has a long history of innovative cable management and protection and connector interfaces for heavy-duty vehicles. Based on the specific and evolving requirements for electric heavy-duty vehicles, the Harnessflex® cable protection team works closely with many electric vehicle manufacturers, transportation businesses and OEMs on protection solutions for high voltage electrical wiring and connectors.



ABB's Harnessflex® Specialist Conduit Systems offers a wide range of solutions

from our standard general purpose range (black) to our specialist solutions for extreme temperatures (Harnessflex® X-Temp™) and Harnessflex® EVO (Electrical Vehicle Orange).

⁴ U.S. Department of Energy, "Vehicle Weight Classes & Categories, "



The ABB team works

with commercial and heavy-duty vehicle OEM partners to assess requirements and develop cable management and protection solutions that enhance reliability and performance in a dynamic and constantly changing environment.



4 Maximising lifespan and performance

ABB Installation Products is often asked to help develop and integrate solutions to enhance reliability and performance of all types of commercial and HDVs. At the same time, global climate change initiatives to lower carbon emissions and improve sustainability are driving the shift toward electric modes of transport.

Some of the factors commercial equipment and HDV makers ask ABB to help them address include:

- How can I increase uptime?
- How do I protect against abrasion, corrosion, ingress, stress, vibration and other impacts?
- What lower-emission solutions are available to ensure heavy-duty vehicle reliability and performance?



ABB offers solutions that can help consistently:

- **Protect** commercial and HDV investments
- **Enhance** safety and reliability
- **Improve** equipment performance
- **Extend** the life of the vehicle
- **Lower** emissions and meet or exceed evolving requirements
- **Reduce** installation and maintenance

With an understanding of OEM and harnessmaker requirements, ABB's Harnessflex® team produces an extensive line of products and bespoke designs that easily integrate into the wiring harness of commercial and HDVs.

As a result, Harnessflex® has developed a wide range of durable and protective backshells for commonly-used electrical connectors, cable management solutions, cable glands, vibration friendly profile conduit, and fittings that help defend effectively against high pressure wash-down, excessive cable strain, corrosion and mechanical abrasion. These incorporate standard low voltage systems, including those exposed to the temperature extremes of modern diesel engines, as well as high voltage, clean power systems such as hydrogen and battery systems.

5 Connecting & protecting

Connecting and protecting electrical wiring is essential to the performance and power of commercial and heavy-duty vehicles.

As more applications integrate cable and conduit technology, data systems, sensors, and compact and complex wiring, proven cable management and protection can make a significant difference in performance and reliability. Add to this tightening regulations and higher customer expectations.

Some commercial and heavy-duty vehicle manufacturers are accelerating implementation of lower-emission solutions that maintain reliability and performance.

When assessing cable management and protection, there are a number of key areas we consistently find commercial and heavy-duty vehicle manufacturers need to consider.



6 Environment

Whether it's a fire truck that maneuvers through traffic in response to an emergency, a delivery vehicle in constant use, or logging equipment that travels extreme terrain, the protection needs to match the application and working environment.

It's vitally important that vehicle wiring harnesses are able to withstand intense strain when operating in the field. With an intuitive, practical design and proven strength when subjected to intense testing, the Harnessflex® Heavy Duty Series offers safer and more secure cable protection by providing a continuous sturdy link between harness and connector. The series is designed for use with all TE HDSCS and Aptiv CTCS XP Type B & E connectors, helping maintain continuous vehicle operation even in the toughest operating conditions.

Harnessflex® Heavy Duty Series performed

33% better



than the standard backshell for the TE HDSCS connector.

Harnessflex® systems are evaluated using a Z010 tensile testing machine for testing pull-out resistance in all application areas. Whether in quality control or research projects, this tensile testing process assures outstanding performance in even the most challenging environments.

To test the performance of the Harnessflex® Heavy Duty Series against the standard backshells for the TE HDSCS connectors, tensile testing was conducted under the following recognised regulatory conditions:

- Tensile strength - ISO 527 55
- Elongation at break - ISO 527 50

For this test, the conduit was 200mm length with the appropriate backshell. Using a tensile testing machine, force was applied based on ISO classification and the conduit had to hold the applied force for 120 seconds.

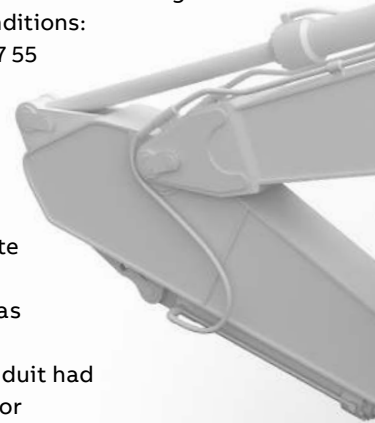

After the completed test, the conduit system with backshell had to still be intact with no visible damage (without magnification). Results confirmed that when subjected to the same testing conditions, the Harnessflex® Heavy Duty Series performed **33% better** than the standard backshell for the TE HDSCS connector. This validates a correctly installed Harnessflex® backshell is more resistant to intense strain and more likely to safely protect critical wiring when subjected to extreme operating conditions.

As an integrated solution, Harnessflex® conduits, fittings and accessories are designed to be used as a combined system and are extensively tested in a number of ways:

- Compression and crush
- Tensile and pull off
- Ingress protection (jet wash safe)
- Oil and chemical resistance
- UV resistance
- Extreme cold and hot temperatures
- Vibration and abrasion
- Protection from dust, debris and paint with Harnessflex® connector shields

This robust testing helps Harnessflex® complete system solutions provide dependable routing and protection of electrical wiring against damage by impact, mechanical abrasion, liquid ingress, corrosive salts and chemicals, and extreme temperatures.

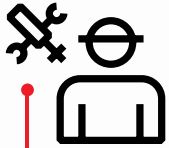

Simple operator error

is one of the leading causes of reduced equipment lifespan.



7 Operation

Just as a car can be driven aggressively or inefficiently, operators can run heavy-duty machinery in ways that cause damage or excessive wear on components, strain the engine or brakes, or waste fuel. To lengthen the life of equipment, training can help operators balance power and efficiency. Some machinery has technology that can monitor utilisation and report on usage and adjustments. This data can help resolve operational challenges and keep things running smoothly.

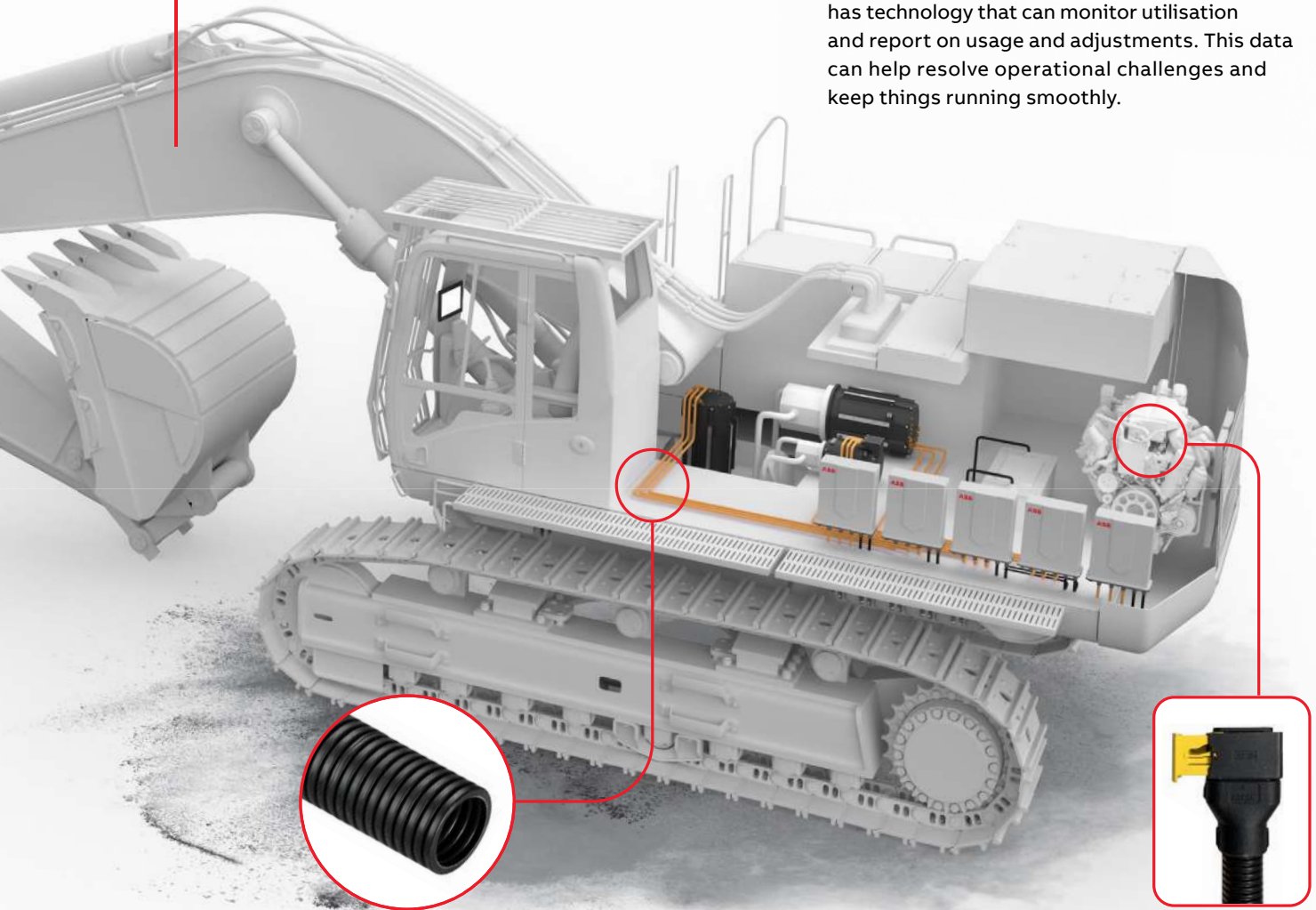

8 Assembly, installation and maintenance processes

For the harnessmaker, the labor involved in assembling the harness is an important consideration. If parts are difficult to put together, this adds to the installation time and ultimately overall costs. When the competitor backshell for TE connectors was tested for ease of assembly, clips were found to be hard to open with a screwdriver, causing parts to slip and creating potential risk of hand injuries. With bigger overall dimensions than the Harnessflex® Heavy Duty Series, the bulky and square design of the other backshell and protruding clips take up valuable space in the engine compartment.

Although the connector plug sits inside the backshell, there is no retaining clip for the conduit, which falls out easily and makes assembly tedious. Without being held firmly in place by hand, components could drop out and disrupt installation, cause damage, and increase both assembly time and cost.

By comparison, the Harnessflex® Heavy Duty Series is easy to open with a screwdriver and the backshell is a hinged, one-piece design that smoothly closes around and captures any parts, helping to make Harnessflex® assembly operations fast and easy. The tightly constructed backshell is also ideal for engine harness, providing wire protection without taking up valuable engine space.

Continued



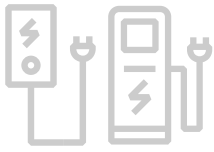

9 Fuel source

For electric and lower-emission gas machines, protection of critical vehicle parts and wiring is paramount to avoid additional repair costs, as well as maintain vehicle reliability and productivity. While all vehicles have wiring that needs to be protected, heavy-duty electric vehicles contain even more types and amounts of critical wiring that requires the optimum level of cable protection to facilitate operation and maintain productivity over the long haul.

Heavy-duty EV systems also operate at higher running temperatures and can encounter damage from operating in demanding environments. New electric vehicle offerings without the right cable protection system may be more prone to electrical failure, resulting in breakdowns, timetable disruptions and costly repairs.

To specifically protect essential wiring on modern electric vehicles and support reliability, ABB developed the **Harnessflex® Electric Vehicle Orange (EVO)** conduit system. With a standard vibration friendly profile (VFP) and UV and heat stabilisation, it provides durable cable protection in harsh conditions and helps minimise the risk of electrical failure.

Additional considerations include Exhaust Gas Recirculation (EGR) systems that recycle an engine's waste gases, the use of single or multiple turbos to improve tractability, and power and fuel efficiency – all of which contribute to higher temperature areas within a vehicle's engine. Combined with hot engine oil, manufacturers need a comprehensive solution to protect wiring and help ensure engine connectors can withstand extreme heat.

As OEMs work to improve safety and meet tighter emission standards, products such as Harnessflex® extreme temperature line is designed and tested to protect against extreme cold and heat, while meeting the demands of today's engines. The range of conduits and fittings for extreme temperatures protect wiring and enable successful operation up to 200°C. Additional long-term heat aging and tensile and impact strength testing was performed to establish the reliability and validity of the range and that Harnessflex® can help safeguard wiring in lower-emission machines.



10 Footprint

While space is already limited inside a vehicle, some engine types have tighter constraints and more complex control systems.

For example, hydrogen engines have a smaller footprint and require connector protection with increased strain relief. Harnessflex® has developed smaller wiring harnesses to fit these compact footprints and a range of systems, applications and environments.

In addition to analysing the above factors, cost and frequency of replacement are important considerations. As standard, Harnessflex® conduit systems carry a 5-year warranty, with some customers having reported Harnessflex installations that have been in service since the 1980s. Importantly, based on previous testing results, Harnessflex conduit systems also provide 10% to 150% greater life expectancy in dynamic or vibrating applications when compared with other products.

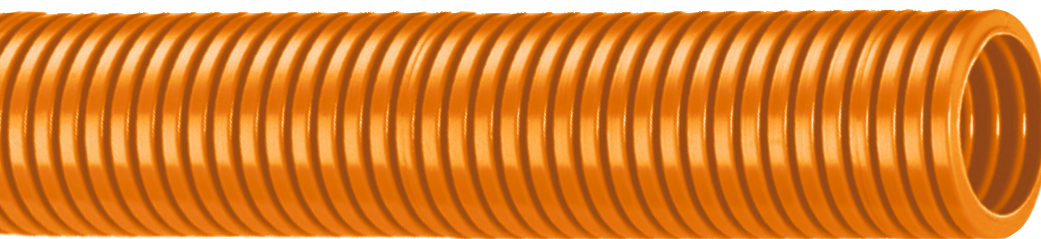

Harnessflex®
EVO

Electric Vehicle Orange
conduit system

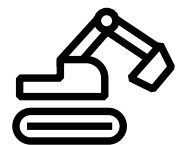

Equipped with
VFP

Vibration Friendly Profile
Harnessflex® conduit systems



Harnessflex[®]

SPECIALIST CONDUIT SYSTEMS

The ABB Installation Products team works with commercial and heavy-duty vehicle harnessmakers and OEMs around the world to match the right **Harnessflex**[®] solution to the requirements and protect vulnerable connectors from exposure to harsh elements and the impact of foreign bodies or jet washing, all of which can cause vehicle malfunction and failure.

 For more information, visit:
www.pankajelectricals.com

From construction equipment and electric vehicles to mass transit and robotics, for the past 85 years ABB has developed cable management solutions for the most demanding conditions that meet or exceed industry standards. Amid an evolving regulatory environment and the shift to electric, heavy-duty vehicle manufacturers are working to earn energy incentives, avoid future fines and help customers drive environmentally-friendly changes.

With intense focus on lowering emissions and gradually introducing new commercial and heavy-duty electric vehicles, OEMs are seeking solutions that protect vehicle wiring while maintaining performance and reliability. Using a complete **Harnessflex**[®] system in a heavy-duty vehicle can help reduce running costs, minimise breakdowns and downtime, and boost overall productivity.

As a global source-to-socket solution provider, ABB is laying the foundation for clean transportation, helping customers reduce their impact on the environment and providing reliable, secure products for many applications.

Acknowledgments

We thank the ABB Electrification and ABB Installation Products experts who provided market insights, including Nathan Cook, Martyn Bree, Harpreet Kaur and Elliot Nunes. We also acknowledge our communications and project team, including Hannah Anthony, Karl Blakesley, Barbara Brokken and Cristy Williams.

PANKAJ ELECTRICALS

Cable Management Products
1105 A, 11th Floor, Logix City Centre
sector-32, Noida, 201301, U.P
Technical Support e-mail:
marketing@pankajelectricals.com

www.pankajelectricals.com



About Cable Management products

ABB Installation Products Division, formerly Thomas & Betts, is a global leader in the design, manufacture and marketing of products used to manage the connection, protection and distribution of electrical power in industrial, construction and utility applications. With more than 200,000 products under more than 38 premium brand names, ABB Installation Products solutions can be found wherever electricity is used.